

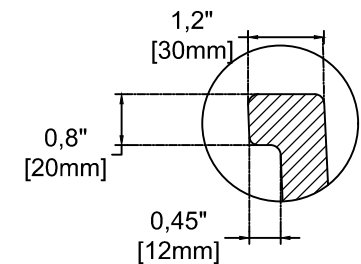

ISVEA

1962 ITALIA

TECHNICAL DRAWING / TEKNİK ÇİZİM

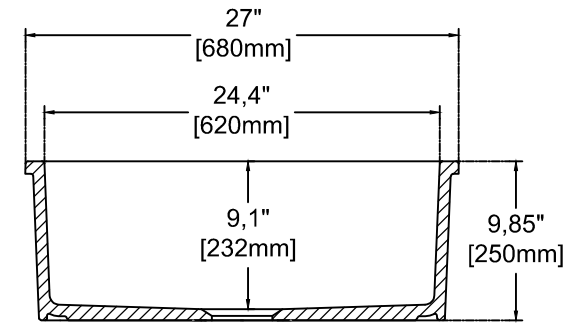
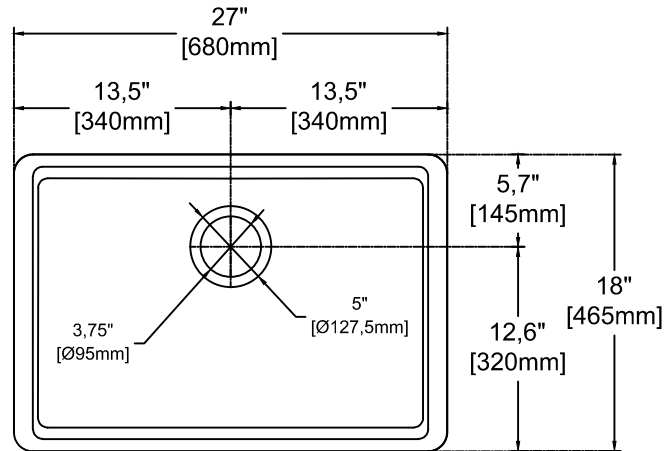
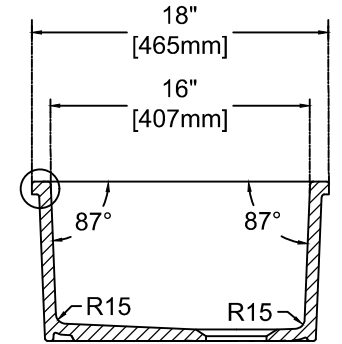
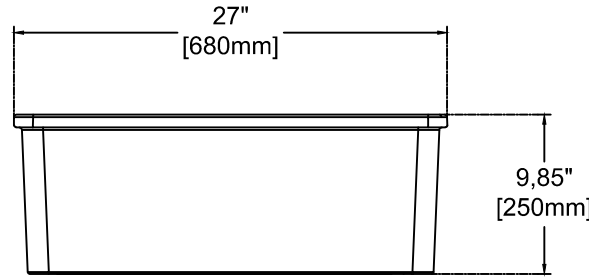
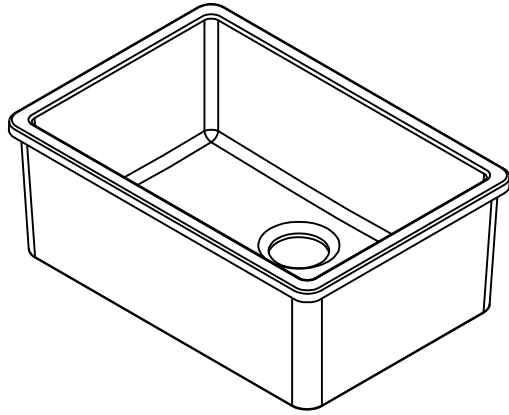

CODE / KOD : 10PC80068

SIZE : 27x18,3 inç

680 x 465 mm

DESCRIPTION / AÇIKLAMA : Pescara Undermount/set-in 27"

TOLERANCE / TOLERANS : 100 mm ± 1 %